

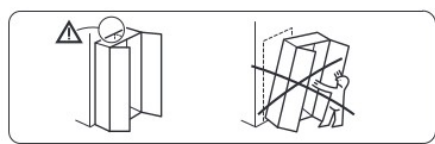

# Ich baue einen Schrank...

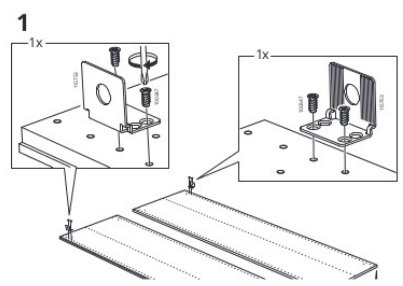

21

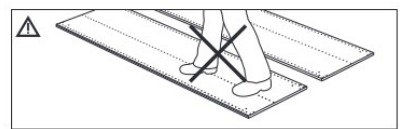
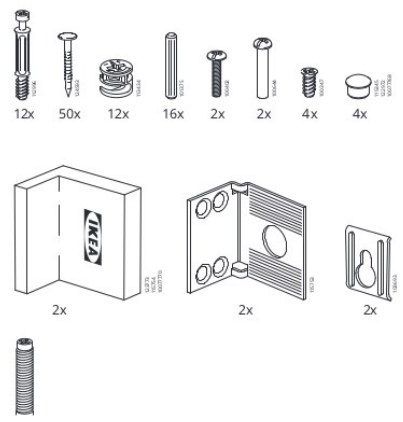
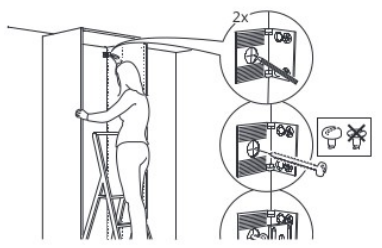

22

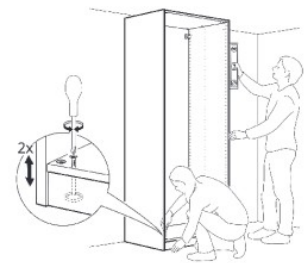

23

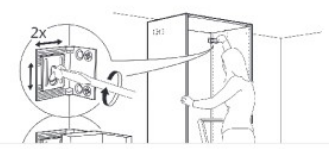



# Ich baue einen Schuppen...

- Platz ungefähr 1,80m x 1,80
- Höhe,  
mal gucken
- Mit Restholz
- Möglichst  
innen  
trocken



# Schuppen: Baumaterial



# Schuppen: Freiräumen



# Schuppen: Fundament





# Ich baue einen Schuppen

- Wie machen es andere?
- Kann ich das überhaupt?
- Für wen mache ich es?
- Wie fange ich an?
- Wem kann man vertrauen?



# Gemeindebau

Psalm 127, 1

Denn wenn der HERR nicht das Haus baut, ist die Arbeit der Bauleute vergeblich.

Apostelgeschichte 4, 31

Gott will bauen.